

JAINA CONVENTION 2025

Unity in Diversity: A Path to Peace

July 3 - 6, 2025 | Chicago, IL



Unity in Diversity: A Path to Peace

July 3 - 6, 2025 | Chicago, IL

Sponsorship Opportunities

www.jainaconvention.org



JAINA CONVENTION 2025

Unity in Diversity: A Path to Peace

July 3 - 6, 2025 | Chicago, IL

Fundraising Team



Chair, Detroit, MI
313-598-2544

RAJIV SHAH



Co-Chair, Milpitas, CA
408-206-9049

BIREN SHAH



Co-Chair, Tampa, FL
813-482-3802

DEEPAK PAREKH



Co-Chair, Chicago, IL
847-490-5518

HETAL KAMDAR



Co-Chair, NY
917-783-7017

RAJEEV PANDYA



Member, Chicago, IL
630-501-4373

ATUL SHAH



Member, Miami, FL
305-890-1758

BINDESH SHAH



Member, Chicago, IL
847-420-9025

DIPAK DOSHI



Member, Chicago, IL
630-215-4049

DIPAK KAPADIA



Member, Chicago, IL
630-379-9080

HITESH SHAH



Member, Dallas, TX
847-668-3785

JAGAT SHAH



Member, NJ
201-220-2341

JIGAR SHAH



Member, Chicago, IL
847-477-5246

JIGNESH JAIN



Member, NY
917-744-9138

KALPANA GANDHI



Member, Daytona Beach,
FL
386-8715455

KETU SHETH



Member, Toronto,
Canada
416-877-1442

LATA CHAMPSEE



Member, Los Angeles,
CA
909-376-4027

MAHESH WADHER



Member, Memphis, TN
901-240-2602

DR MANOJ JAIN



Member, Los Angeles,
CA
562-244-9035

NITIN SHAH

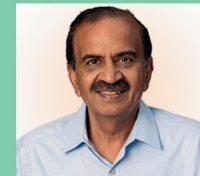

Member, San Francisco,
CA
408-981-4645

PREM JAIN



Member, Washington,
DC
301-748-8111

SHARAD DOSHI



Member, Chicago, IL
847-596-0431

VASANT SHAH



Member, Atlanta, GA
678-523-5997

VIJAY KOTHARI



Member, Chicago, IL
847-809-8756

VIPUL SHAH



Member, Los Angeles, CA
714-936-5300

YOGESH SHAH

www.jainaconvention.org/sponsorship



JAINA CONVENTION 2025

Unity in Diversity: A Path to Peace

July 3 - 6, 2025 | Chicago, IL

Dear Friends,

December 2024

Jai Jinendra!

JAINA cordially invites you to attend the 23rd Biennial JAINA convention to be held from July 3 to July 6, 2025. It's a premier event that brings the Jain community together, where more than 5,000 Jains gather from across the world. It was 1981 when we first came together as Jains and formed JAINA – an organization that binds us all.

JAINA is an acronym for the Federation of Jain Associations In North America, an umbrella organization of 70+ Jain Organizations representing 200,000 members in the USA and Canada with a mission to preserve, practice, and promote Jain Dharma and the Jain Way of Life. With the blessings of Acharya Sushil Kumarji and Gurudev Chitrabhanuji, JAINA was founded in 1981 and formalized in 1983. JAINA is the largest organization of Jains outside India and conducts its various programs and initiatives through several committees. The dream of unity of all Jains is alive and thriving in North America through JAINA, as it represents Jains of all sects from all regions of the world.

The theme of the 2025 Convention is "UNITY IN DIVERSITY: A PATH TO PEACE." Unity in diversity is not merely a catchphrase; it's a roadmap to peace. Embracing our differences, we weave a vibrant tapestry of understanding and respect. Each thread, unique in color and texture, contributes to the beauty of the whole. In unity, we find strength; in diversity, we find richness; and in this harmony, we pave the path to lasting peace.

We know and appreciate that such events are possible only through outstanding support and generous contributions from leaders and donors like you and our community's many young and adult volunteers. We sincerely appreciate the generous donations and leadership support that you have so kindly provided throughout the past and look forward to your contributions to help cherish, preserve, and rejuvenate our culture and heritage. You will be able to participate and contribute by becoming a sponsor of any of the events during the JAINA Convention or by advertising in the souvenir book. All donations to JAINA are tax deductible.

We count on your generous support. For additional information about contributing, please contact one of us on the left side or email us at conventionfundraising@jaina.org. We extend our special invitation to you and your family and look forward to meeting you at the upcoming convention.

Kind regards,

Rajiv Shah
Fundraising Committee Chair

Atul Shah
Convention Convenor

Bindesh Shah
JAINA President

www.jainaconvention.org/sponsorship



JAINA CONVENTION 2025

Unity in Diversity: A Path to Peace

July 3 - 6, 2025 | Chicago, IL

Convention Sponsorship Opportunities At-A-Glance

GRAND SPONSORSHIPS & LABHS

Mahasanghpati	\$125,001	(2 labhs)	Not Available	Sanghpati	\$65,001	(4 labhs)	Available
Temple Dedication & Dwar Opening	\$41,001	(1 labh)	Not Available	Souvenir Bag Sponsor	\$30,001	(1 labh)	Not Available
Grand Sponsor of Swamivatsalya	\$25,001	(10 labhs)	Available	Corporate Sponsor	\$25,001	(5 labhs)	Available
Thermos/Water Bottle Sponsor	\$20,001	(1 labh)	Not Available	Corp. Non-Profit Sponsor	\$12,501	(5 labhs)	Available

SWAMIVATSALYA LABHS

Dinner	\$15,001	(10 labhs)	Available
Lunch	\$11,001	(10 labhs)	Available
Breakfast	\$7,501	(10 labhs)	Available
Aradhak & Sadhu/Sadhvi Meals	\$5,001	(3 labhs)	Not Available
Boiled & Regular Water	\$5,001	(5 labhs)	Available
Tea & Snacks	\$2,501	(10 labhs)	Available

NEXT-GEN SPONSORSHIPS

Young Jain Professionals (YJP)	\$3,001	(5 labhs)	Available
Jain Academic Bowl (JAB)	\$3,001	(5 labhs)	Available
Jain Connect	\$3,001	(5 labhs)	Available
Youth Raas Garba	\$3,001	(5 labhs)	Available
Youth Activities by YJA	\$3,001	(5 labhs)	Available
Kids' Club	\$3,001	(5 labhs)	Available

TEMPLE LABHS

Jainism Exhibition	\$7,501	(3 labhs)	Available
Mangal Divo	\$2,501	(6 labhs)	Available
Aarti	\$2,001	(18 labhs)	Available
Astapad - Tirthankar Pratimaji	\$1,501	(22 labhs)	Available
Astapad - Tirthankar Pratimaji	Gheeboli	(2 labhs)	Available
TirthankarJivit Pratimaji	Gheeboli	(2 labhs)	Available
Srimad Rajchandra	Gheeboli	(1 labh)	Available
Gau Dohan Mahavir Swami Pratimaji	Gheeboli	(1 labh)	Available

PROGRAMMING & OTHER LABHS

Maharathi (Transportation)	\$11,001	(4 labhs)	Available
Bollywood Night	\$10,001	(5 labhs)	Available
Virtual Tirthdham Darshan	\$7,501	(5 labhs)	Available
Drama	\$5,001	(5 labhs)	Available
Cultural Show	\$5,001	(5 labhs)	Available
Procession Float Sponsors	\$5,001	(4 labhs)	Available
JGT	\$3,001	(5 labhs)	Available
Sadhu/Sadhvi Procession Ride	\$3,001	(10 labhs)	Available
Program Guide	\$2,001	(4 labhs)	Available

SOUVENIR SPONSORSHIPS

Back Cover	\$21,001	(1 labh)	Available
Inside Front Cover	\$15,001	(1 labh)	Available
Inside Back Cover	\$15,001	(1 labh)	Available
Featured Page	\$5,001	(10 labhs)	Available
Full Double Page	\$2,501	(5 labhs)	Available
Full Page	\$1,501	(30 labhs)	Available
Half Page	\$751	(60 labhs)	Available

BOOTH SPONSORSHIPS

10' x 10' Prime Corner (For Profit)	\$2,501	(12 labhs)	Available
10' x 10' Booth (For Profit)	\$2,001	(10 labhs)	Available
10' x 10' Booth (Non-Profit)	\$1,501	(5 labhs)	Not Available
Table Only @CC (For Profit)	\$1,251	(2 labhs)	Not Available
Table Only @CC (Non-Profit)	\$1,001	(2 labhs)	Not Available
Table Only @Hyatt (For Profit)	\$1,251	(3 labhs)	Available
Table Only @Hyatt (Non-Profit)	\$1,001	(3 labhs)	Available
Banner Display (Non-Profit)	\$751	(10 labhs)	Available

SPEAKER SPONSORSHIPS

Keynote Speakers	\$7,501	(4 labhs)	Available
Sadhu/Sadhvi Pravachans	\$3,001	(10 labhs)	Available
Featured Speakers	\$3,001	(10 labhs)	Available
Session Speakers	\$1,501	(25 labhs)	Available

RESERVED SEATING, WELL WISHER

Reserved Seating	\$501 / seat	(500 labhs)	Available
JAINA Well Wisher	\$251	(no limit)	Available

To sponsor or if you have any questions, contact
Rajiv Shah (Fundraising Chair) at conventionfundraising@jaina.org.



Updated as of: Jan 19, 2025.
Scan the QR code for the latest status

Not Available
Available



JAINA CONVENTION 2025

Unity in Diversity: A Path to Peace

July 3 - 6, 2025 | Chicago, IL

Maha Sanghpati

(Max 2 Sponsors) \$125,001 each

- Prominent recognition with a plaque during the opening or closing ceremony
- VIP seating (up to 8 family members) in all major convention events
- Welcome remarks for 10 mins on a main stage
- Hotel Suite (one) for Thu, Fri, and Sat night
- Prominent JAINA recognition plaque
- Prominent recognition email/post on social media
- Welcome banner at a prominent location with the sponsor's name with picture
- Lead the procession with a special ribbon (up to 8 family members)
- Complimentary registration for up to 8 family members
- Photograph of family in specially designed full page in souvenir book
- Family picture on the home page of the convention website.
- Family picture on the convention sponsorship webpage
- 180 second family video played during the main evening program
- Complimentary parking service for 2 cars with in/out privileges



Unity Through Compassion

"Parasparopagraho Jīvānām" teaches us that all life is interdependent. Together, let's embody this principle, creating a more compassionate and unified community.





JAINA CONVENTION 2025

Unity in Diversity: A Path to Peace

July 3 - 6, 2025 | Chicago, IL

Sanghpati

(Max 4 Sponsors) \$65,001 each

- Prominent recognition with a plaque during the opening or closing ceremony
- VIP seating (up to 6 family members) in all major Convention events
- Welcome remarks for 5 mins on a main stage
- Hotel Suite (One) for Thu, Fri, and Sat night
- Prominent JAINA Recognition Plaque
- Prominent Recognition Email/Post on Social Media
- Welcome Banner at a prominent location with the sponsor's name with a picture
- Lead the Procession with a special ribbon (up to 6 family members)
- Complimentary Registration for up to 6 family members
- Photograph of family in specially designed full page in souvenir book
- Family picture on the home page of the convention website.
- Family picture on the Convention Sponsorship Webpage
- 90 Seconds Family Video Played during the Main Evening Program
- Complimentary Parking service for 2 cars with in/out privileges



Celebrating Our Diversity

At JAINA Convention 2025, we celebrate the rich diversity within the Jain community, embracing the various traditions that bind us together as one.





JAINA CONVENTION 2025

Unity in Diversity: A Path to Peace

July 3 - 6, 2025 | Chicago, IL

Temple Sponsorships

Temple Dedication and Dwar Opening (Max 1 Sponsor) - \$41,001

- Temple inauguration labh
- VIP Seating (up to 4 family members) in all major Convention events
- Prominent Recognition with Plaque During Opening or Closing Ceremony
- Hotel Suite (one) for Thu, Fri, Sat night
- Welcome Banner at Temple location with Sponsors' Name with picture
- Prominent JAINA Recognition Plaque
- Lead the procession with a special ribbon (up to 4 family members)
- Complimentary Registration up to 4 family members
- Photograph of family in specially designed full page in Souvenir Book
- Family photograph on the Convention Sponsorship Webpage
- Complimentary Parking service for one car with in/out privilege

Jainism Exhibition (Max 3 Sponsors) \$7,501 each

- Reserved Seating (up to 2 family members) in all major Convention events
- Prominent JAINA Recognition Plaque
- Name Recognition in Souvenir - part of the Sponsors Page
- Family picture on the Convention Sponsorship Webpage

Astapad Tirthankar Pratimaji (Max 22 Sponsors) \$1,501 each

- Labh of chosen Astapad Tirthankar # 2 to 23
- Name Recognition in Souvenir - part of the Sponsors Page
- Recognition on the Convention Sponsorship Webpage





JAINA CONVENTION 2025

Unity in Diversity: A Path to Peace

July 3 - 6, 2025 | Chicago, IL

Temple Sponsorships

Temple Mangal Divo (Max 6 Sponsors) - \$2,501 each

- Labh of chosen Mangal Divo
- Name Recognition in Souvenir - part of the Sponsors Page
- Recognition on the Convention Sponsorship Webpage

Temple Aarti (Max 18 Sponsors) - \$2,001 each

- Labh of chosen Aarti
- Name Recognition in Souvenir - part of the Sponsors Page
- Recognition on the Convention Sponsorship Webpage

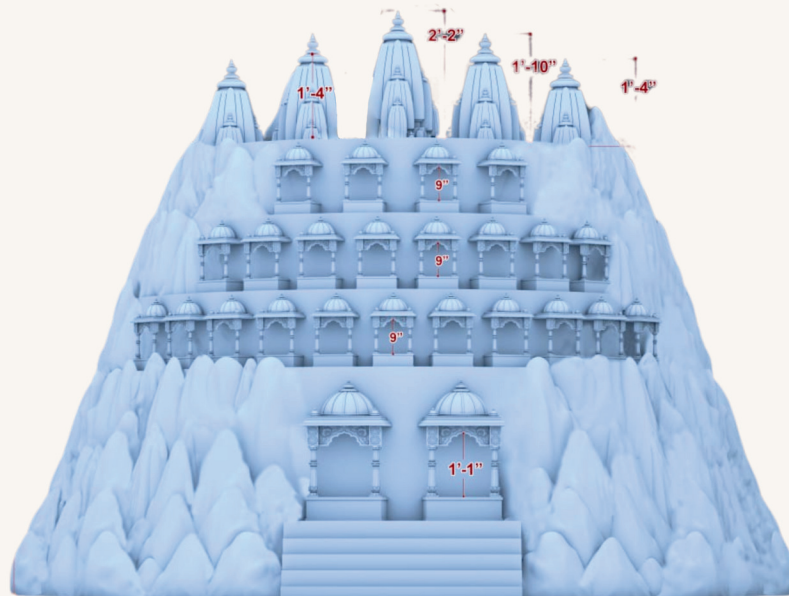



JAINA CONVENTION 2025

Unity in Diversity: A Path to Peace

July 3 - 6, 2025 | Chicago, IL

Gheeboli Sponsorships

Gau Dohan Pratimaji (Max 1 Sponsor) - Silent Gheeboli

- Labh of Gau Dohan Mahavir Swami Pratimaji (~36" in size)
- Name Recognition in Souvenir - part of the Sponsors Page
- Recognition on the Convention Sponsorship Webpage

Astapad Tirthankar Pratimaji (Max 2 Sponsors) - Silent Gheeboli

- Labh of chosen Astapad Tirthankar # 1 (Digambar Adinath - 13" in size), 24(Mahavir Swami - 13" in size)
- Name Recognition in Souvenir - part of the Sponsors Page
- Recognition on the Convention Sponsorship Webpage

Tirthankar Jivit Pratimaji (Max 2 Sponsors) - Silent Gheeboli

- Labh of one of the two Mahavir Swami Jivit Pratimaji (~10" in size)
- Name Recognition in Souvenir - part of the Sponsors Page
- Recognition on the Convention Sponsorship Webpage

Smd. Rajchandra Seating Pratimaji (Max 1 Sponsor) - Silent Gheeboli

- Labh of Smd. Rajchandra Seating Pratimaji (~18" in size)
- Name Recognition in Souvenir - part of the Sponsors Page
- Recognition on the Convention Sponsorship Webpage



JAINA CONVENTION 2025

Unity in Diversity: A Path to Peace

July 3 - 6, 2025 | Chicago, IL

Souvenir Gift Sponsorships

Souvenir Bag (Max 1 Sponsor) \$30,001

- VIP Seating (up to 4 family members) in all major Convention events
- Prominent Recognition with Plaque During Opening or Closing Ceremony
- Hotel Room (one) for Thu, Fri, and Sat Night
- Prominent JAINA Recognition Plaque
- Lead the procession with a special ribbon (up to 4 family members)
- Complimentary Registration up to 4 family members
- Photograph of family in specially designed full page in Souvenir Book
- Company Logo on Convention Souvenir Bag
- Photograph on the Convention Sponsorship Webpage
- Complimentary Parking service for one car with in/out privilege



Souvenir Thermos/Water Bottle (Max 1 Sponsor) \$20,001

- Reserved Seating (up to 2 family members) in all major Convention events
- Prominent JAINA Recognition Plaque
- Complimentary Registration up to 2 family members
- Company Logo on Convention Souvenir Thermos bottle
- Photograph on the Convention Sponsorship Webpage
- Complimentary Parking service for one car with in/out privilege
- Photograph of family in specially designed full page in souvenir book





JAINA CONVENTION 2025

Unity in Diversity: A Path to Peace

July 3 - 6, 2025 | Chicago, IL

Corporate Sponsorships

Corporate For-Profit Sponsorship (Max 5 Sponsors) \$25,001 each

- 10'x10' Booth in the Convention Center or main Lobby
- Reserved Seating (up to 4 members) in all major Convention events
- Prominent Recognition with Plaque During Opening or Closing Ceremony
- Prominent Recognition Email/Post on social media
- Welcome Banner at a prominent location with the Sponsors' Name with picture
- Prominent JAINA Recognition Plaque
- Complimentary Registration up to 4 members
- Full Page Ad in Souvenir
- Photograph on the Convention Sponsorship Webpage
- Complimentary Parking service for 1 car with in/out privilege

Corporate Non-Profit Sponsorship (Max 5 Sponsors) \$12,501 each

- 10'x10' Booth in the Convention Center or main Lobby
- Reserved Seating (up to 2 members) in all major Convention events
- Prominent Recognition with Plaque During Opening or Closing Ceremony
- Prominent Recognition Email/Post on social media
- Welcome Banner at a prominent location with the Sponsors' Name
- Prominent JAINA Recognition Plaque
- Half Page Ad in Souvenir
- Recognition on the Convention Sponsorship Webpage





JAINA CONVENTION 2025

Unity in Diversity: A Path to Peace

July 3 - 6, 2025 | Chicago, IL

Swamivatsalya Sponsorships

Swamivatsalya Grand Sponsorship (Max 10 Sponsors) \$25,001 each

- Prominent recognition with a plaque during the opening or closing ceremony
- VIP seating (up to 4 family members) in all major Convention events
- Hotel Room (One) for Thu, Fri, and Sat night
- Prominent JAINA Recognition Plaque
- Welcome Banner in the Dining area with the sponsor's name with picture
- Lead the Procession with a special ribbon (up to 4 family members)
- Complimentary Registration for up to 4 family members
- Photograph of family in specially designed full page in souvenir book
- Picture on the Convention Sponsorship Webpage
- Complimentary Parking service for one car with in/out privileges

Dinner

(Max 10 Sponsors) \$15,001 each

- Reserved Seating (up to 2 family members) in all major Convention events
- Prominent JAINA Recognition Plaque
- Banner Recognition in Food Court
- Full Page Ad in Souvenir
- Family picture in Souvenir - part of the Sponsors Page
- Family picture on the Convention Sponsorship Webpage

Lunch

(Max 10 Sponsors) \$11,001 each

- Reserved Seating (up to 2 family members) in all major Convention events
- Prominent JAINA Recognition Plaque
- Banner Recognition in Food Court
- Half Page Ad in Souvenir
- Family picture in Souvenir - part of the Sponsors Page
- Family picture on the Convention Sponsorship Webpage





JAINA CONVENTION 2025

Unity in Diversity: A Path to Peace

July 3 - 6, 2025 | Chicago, IL

Swamivatsalya Sponsorships

Breakfast

(Max 10 Sponsors) \$7,501 each

- Reserved Seating (up to 2 family members) in all major Convention events
- Prominent JAINA Recognition Plaque
- Banner Recognition in Food Court
- Name Recognition in Souvenir - part of the Sponsors Page
- Family picture on the Convention Sponsorship Webpage

Convention Water and Boiled Water

(Max 5 Sponsors) \$5001 each

- Reserved Seating (up to 2 family members) in all major Convention events
- Prominent JAINA Recognition Plaque
- Banner Recognition in Food Court
- Name Recognition in Souvenir - part of the Sponsors Page
- Family picture on the Convention Sponsorship Webpage

Aradhak and Sadhu/Sadhvi Meals

(Max 3 Sponsors) \$5001 each

- Reserved Seating (up to 2 family members) in all major Convention events
- Prominent JAINA Recognition Plaque
- Banner Recognition in Food Court
- Name Recognition in Souvenir - part of the Sponsors Page
- Family picture on the Convention Sponsorship Webpage

Tea & Snacks

(Max 10 Sponsors) \$2,501 each

- Banner Recognition in Food Court
- Name Recognition in Souvenir - part of the Sponsors Page
- Recognition on the Convention Sponsorship Webpage





JAINA CONVENTION 2025

Unity in Diversity: A Path to Peace

July 3 - 6, 2025 | Chicago, IL

Souvenir Book Sponsorships

Back Cover (Max 1 Sponsor) \$21,001

- Back cover Page of the Souvenir Book
- Reserved Seating (up to 2 family members) in all major Convention events
- Prominent JAINA Recognition Plaque
- Complimentary Registration up to 2 family members
- Complimentary Parking service for one car with in/out privilege
- Picture on the Convention Sponsorship Webpage

Back Inside Cover Page (Max 1 Sponsor) \$15,001

- Back inside cover Page of the Souvenir Book
- Reserved Seating (up to 2 family members) in all major Convention events
- Prominent JAINA Recognition Plaque
- Picture on the Convention Sponsorship Webpage

Front Inside Cover Page (Max 1 Sponsor) \$15,001

- Front inside cover Page of the Souvenir Book
- Reserved Seating (up to 2 family members) in all major Convention events
- Prominent JAINA Recognition Plaque
- Picture on the Convention Sponsorship Webpage

Feature Page (Max 10 Sponsors) \$5,001 each

- Front inside cover Page of the Souvenir Book
- Reserved Seating (up to 2 family members) in all major Convention events
- Prominent JAINA Recognition Plaque
- Picture on the Convention Sponsorship Webpage

Double Full Page (Max 5 Sponsors) \$2,501 each

- Double Page in Souvenir Book
- Recognition on the Convention Sponsorship Webpage

Full Page (Max 30 Sponsors) \$1,501 each

- Full Page in Souvenir Book
- Recognition on the Convention Sponsorship Webpage

Half Page (Max 60 Sponsors) \$751 each

- Half Page in Souvenir Book
- Recognition on the Convention Sponsorship Webpage





JAINA CONVENTION 2025

Unity in Diversity: A Path to Peace

July 3 - 6, 2025 | Chicago, IL

Other Premium Sponsorships

Maharathi/Transportation Sponsorship (Max 4 Sponsors) \$11,001 each

- Reserved Seating (up to 2 family members) in all major Convention events
- Prominent JAINA Recognition Plaque
- Banner on Transportation Buses
- Half Page Ad in Souvenir
- Family picture in Souvenir - part of the Sponsors Page
- Family picture on the Convention Sponsorship Webpage
- Complimentary Parking service for one car with in/out privilege

Virtual Tirthdham Darshan (Max 5 Sponsors) \$7,501 each

- Reserved Seating (up to 2 family members) in all major Convention events
- Prominent JAINA Recognition Plaque
- 2 minutes introduction of the chosen Tirth
- Name Recognition in Souvenir - part of the Sponsors Page
- Family picture on the Convention Sponsorship Webpage

Parade (Procession) Float Sponsorship (Max 4 Sponsors) \$5,001 each

- Reserved Seating (up to 2 family members) in all major Convention events
- Prominent JAINA Recognition Plaque
- Stay in front (or on) the Float during the Procession
- Name Recognition in Souvenir - part of the Sponsors Page
- Family picture on the Convention Sponsorship Webpage

Sadhu/Sadhvi Procession Ride (Max 10 Sponsors) \$3,001 each

- JAINA Recognition Medal Ribbon
- Stay in front (or on) the Float during the Procession
- Name Recognition in Souvenir - part of the Sponsors Page
- Recognition on the Convention Sponsorship Webpage

Program Guide (Max 4 Sponsors) \$2,001 each

- Name Recognition in Program Guide
- Name Recognition in Souvenir - part of the Sponsors Page
- Recognition on the Convention Sponsorship Webpage





JAINA CONVENTION 2025

Unity in Diversity: A Path to Peace

July 3 - 6, 2025 | Chicago, IL

Entertainment Sponsorships

Bollywood Night

(Max 5 Sponsors) \$10,001 each

- Reserved Seating (up to 2 family members) in all major Convention events
- Prominent JAINA Recognition Plaque
- Family picture in Souvenir - part of the Sponsors Page
- Family picture on the Convention Sponsorship Webpage
- Name Displayed OR Announced during the Event

Drama

(Max 5 Sponsors) \$5001 each

- Reserved Seating (up to 2 family members) in all major Convention events
- Prominent JAINA Recognition Plaque
- Name Recognition in Souvenir - part of the Sponsors Page
- Family picture on the Convention Sponsorship Webpage
- Name Displayed OR Announced during the Event

Cultural Show

(Max 5 Sponsors) \$5001 each

- Reserved Seating (up to 2 family members) in all major Convention events
- Prominent JAINA Recognition Plaque
- Name Recognition in Souvenir - part of the Sponsors Page
- Family picture on the Convention Sponsorship Webpage
- Name Displayed OR Announced during the Event

Jains Got Talent (JGT)

(Max 5 Sponsors) \$3,001 each

- JAINA Recognition Medal Ribbon
- Name Recognition in Souvenir - part of the Sponsors Page
- Recognition on the Convention Sponsorship Webpage
- Name Displayed OR Announced during the Event





JAINA CONVENTION 2025

Unity in Diversity: A Path to Peace

July 3 - 6, 2025 | Chicago, IL

Speaker Sponsorships

Keynote Speaker

(Max 4 Sponsors) \$7,501 each

- Reserved Seating (up to 2 family members) in all major Convention events
- Prominent JAINA Recognition Plaque
- Name Recognition in Souvenir - part of the Sponsors Page
- Family picture on the Convention Sponsorship Webpage
- Name on Session Entrance Page
- Introduce the Speaker (7 Mins)

Sadhu/Sadhvi Pravachan

(Max 10 Sponsors) \$3,001 each

- JAINA Recognition Medal Ribbon
- Name Recognition in Souvenir - part of the Sponsors Page
- Recognition on the Convention Sponsorship Webpage
- Name on Session Entrance Page
- Introduce the Speaker (2 Mins)

Featured Speakers

(Max 10 Sponsors) \$3,001 each

- JAINA Recognition Medal Ribbon
- Name Recognition in Souvenir - part of the Sponsors Page
- Recognition on the Convention Sponsorship Webpage
- Name on Session Entrance Page
- Introduce the Speaker (2 Mins)

Session Speakers

(Max 25 Sponsors) \$1,501 each

- Name Recognition in Souvenir - part of the Sponsors Page
- Recognition on the Convention Sponsorship Webpage
- Name on Session Entrance Page
- Introduce the Speaker (2 Mins)





JAINA CONVENTION 2025

Unity in Diversity: A Path to Peace

July 3 - 6, 2025 | Chicago, IL

Booth and Banner Sponsorship

10' x 10' Prime Corner Profit (Max 12 Sponsors) \$2,501 each

- 10'x10' Booth in Convention Center at Prime Corner
- One complimentary registration is included in the cost
- Recognition on the Convention Booth Sponsorship Webpage
- \$250 increase in the above price after Jan 31, 2025

10' x 10' Profit (Max 10 Sponsors) \$2,001 each

- 10'x10' Booth in the Convention Center or the main Lobby
- One complimentary registration is included in the cost
- Recognition on the Convention Booth Sponsorship Webpage
- \$250 increase in the above price after Jan 31, 2025

10' x 10' Non-Profit (Max 5 Sponsors) \$1,501 each

- 10'x10' Booth in the Convention Center or the main Lobby
- One complimentary registration is included in the cost
- Recognition on the Convention Booth Sponsorship Webpage
- \$250 increase in the above price after Jan 31, 2025

Banner Display (Non-Profit) (Max 10 Sponsors) \$751 each

- Banner in a prominent location within the Convention premises
- One complimentary registration is included in the cost
- Recognition on the Convention Booth Sponsorship Webpage
- \$250 increase in the above price after Jan 31, 2025.



JAINA CONVENTION 2025

Unity in Diversity: A Path to Peace

July 3 - 6, 2025 | Chicago, IL

Booth and Banner Sponsorship

Table Only For-Profit @CC (Max 2 Sponsors) \$1,251 each

- Lobby Table in Convention Center
- One complimentary registration is included in the cost
- Recognition on the Convention Booth Sponsorship Webpage
- \$250 increase in the above price after Jan 31, 2025

Table Only Non-Profit @CC (Max 2 Sponsors) \$1,001 each

- Lobby Table in Convention Center
- One complimentary registration is included in the cost
- Recognition on the Convention Booth Sponsorship Webpage
- \$250 increase in the above price after Jan 31, 2025

Table Only For-Profit @Hyatt (Max 3 Sponsors) \$1,251 each

- Lobby Table in Convention Center
- One complimentary registration is included in the cost
- Recognition on the Convention Booth Sponsorship Webpage
- \$250 increase in the above price after Jan 31, 2025

Table Only Non-Profit @Hyatt (Max 3 Sponsors) \$1,001 each

- Lobby Table in Convention Center
- One complimentary registration is included in the cost
- Recognition on the Convention Booth Sponsorship Webpage
- \$250 increase in the above price after Jan 31, 2025



JAINA CONVENTION 2025

Unity in Diversity: A Path to Peace

July 3 - 6, 2025 | Chicago, IL

Booth Layout at Convention Center

First Floor

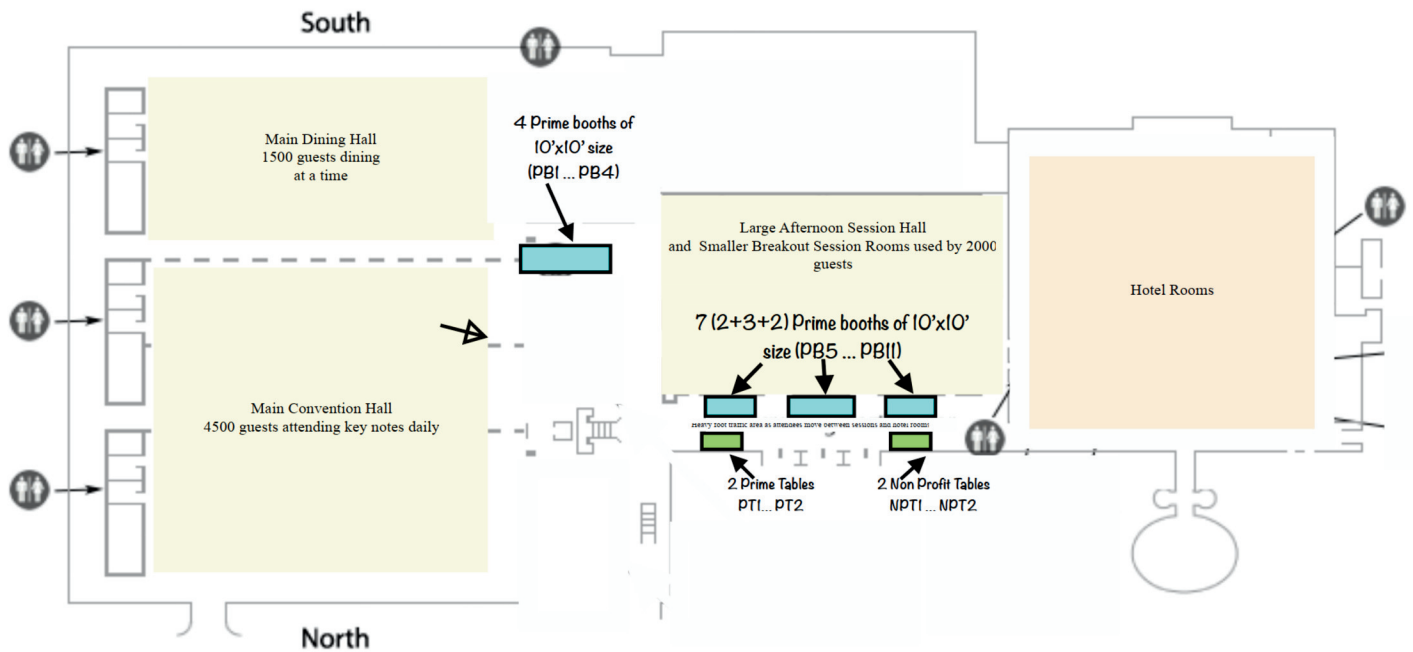

Second Floor

Second Floor - Renaissance Schaumburg Convention Center Hotel

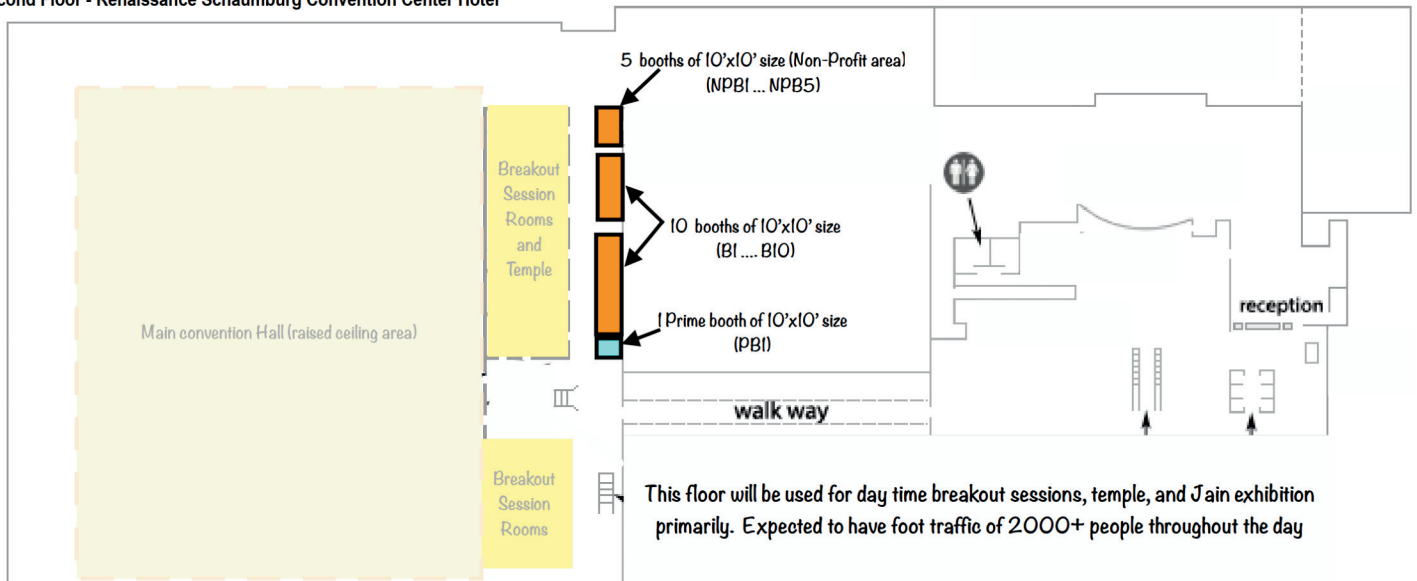



JAINA CONVENTION 2025

Unity in Diversity: A Path to Peace

July 3 - 6, 2025 | Chicago, IL

Booth Layout at Hyatt

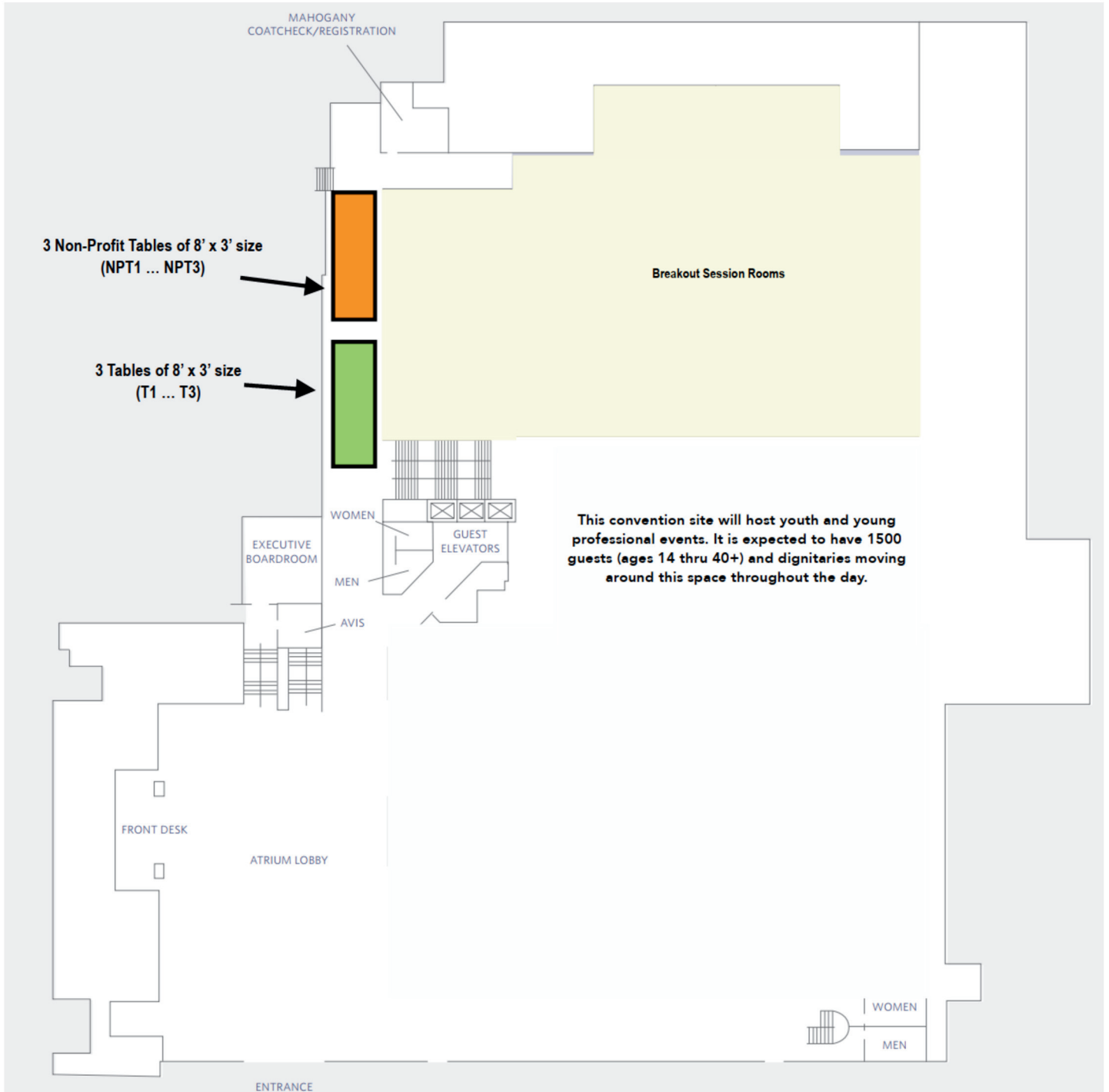



JAINA CONVENTION 2025

Unity in Diversity: A Path to Peace

July 3 - 6, 2025 | Chicago, IL

Next-Gen Sponsorships

Support Youth Programming at JAINA Convention

Young Jain Professionals (YJP)	\$3,001	(5 labhs)
Jain Academic Bowl (JAB)	\$3,001	(5 labhs)
Jain Connect	\$3,001	(5 labhs)
Youth Raas Garba	\$3,001	(5 labhs)
Youth Activities by YJA	\$3,001	(5 labhs)
Kids' Club	\$3,001	(5 labhs)

Next-Gen Labh Benefits

- JAINA Recognition Medal Ribbon
- Name Recognition in Souvenir - part of the Sponsors Page
- Recognition on the Convention Sponsorship Webpage
- Name Displayed OR Announced during the Event





JAINA CONVENTION 2025

Unity in Diversity: A Path to Peace

July 3 - 6, 2025 | Chicago, IL

Next-Gen JAB Sponsorships

(\$1,001 and \$3,001)

Grand Sponsorship \$3,001

- Sponsor the JAB Awards ceremony
- Sponsor family will distribute the awards.
- Reserved seating in front row during the Final match
- Recognition on the JAINA Convention Website
- Recognition in JAIN Newsletter and in Social media
- Only 5 Sponsorship available for this category

Aparigraha Sponsorship \$1,001

- Sponsor a finals match
- Sponsor family will be recognized before the Final game
- Sponsor family will initiate the game by reciting Namokar mantra
- 4 front row seats reserved during the match
- Only 2 sponsorship available for this category

Anekantvad Sponsorship \$501

- Sponsor a Semi-finals match
- Sponsor family will be recognized during the semi-final match
- Sponsor family will initiate the game by reciting Namokar mantra
- 4 front row seats reserved during the match
- Only 4 sponsorship available for this category

Ahimsa Sponsorship \$201* (*Multiple Sponsorship available)

- Sponsor a playoff match
- Sponsor family will be recognized during their sponsored game
- Sponsor family will initiate the game by reciting Namokar mantra
- 2 front row seats reserved during the match





JAINA CONVENTION 2025

Unity in Diversity: A Path to Peace

July 3 - 6, 2025 | Chicago, IL

Reserved Seating and Well Wisher

Reserved Seating \$501 each

For \$501.00 donation (tax-deductible), secure your spot in the reserved seating area.

To reserve, visit <https://www.jainaconvention.org/donation/> and select "Reserved Seating" as the donation purpose.

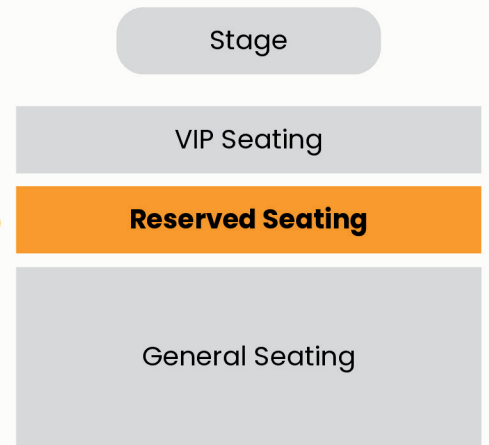

Not actual seating arrangement. This chart is for illustrative purpose only

JAINA Well Wisher \$251 each

- Name Recognition in Souvenir - part of the Sponsors Page
- Every family can participate



JAINA CONVENTION 2025

Unity in Diversity: A Path to Peace

July 3 - 6, 2025 | Chicago, IL

JAINA Convention 2025 Board



Convener
ATUL SHAH



Co-Convener
VIPUL SHAH



Co-Convener
JIGNESH JAIN



Secretary
JAGAT SHAH



Treasurer
KETU SHETH



Member
APURVA BHANSALI



Member
BINDESH SHAH



Member
DIPAK DOSHI



Member
DR. MANOJ JAIN



Member
DR. NITIN SHAH



Member
HARESH SHAH



Member
HEMANT SHAH



Member
HITESH R. SHAH



Member
JAINESH MEHTA



Member
JIGAR SHAH



Member
KALPANA GANDHI



Member
MAHESH WADHER



Member
MEGHNA SHAH



Member
PIYUSH GANDHI



Member
PRADIP GOSALIA



Member
PRAGNESH SHAH

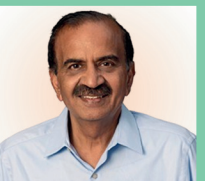

Member
PREM JAIN



Member
RAHUL JAIN



Member
RAJEEV PANDYA



Member
RAJIV SHAH



Member
RAJU SHAH



Member
RAM GADA



Member
SHAN JAIN

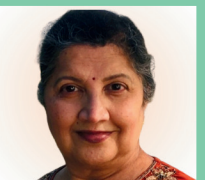

Member
SHOBHA VORA



Member
TEJAS SHAH



Member
USHMA SHAH



Member
VIJAY KOTHARI



Member
YOGESH SHAH



JAINA CONVENTION 2025

Unity in Diversity: A Path to Peace

July 3 - 6, 2025 | Chicago, IL

Why Donate to JAINA Convention?

Empowering Unity, Celebrating Legacy: Your Contribution Shapes the Future of Jains in America

Showcase Your Leadership: Your generous support highlights your influence and leadership, inspiring others to contribute to the progress of the Jain community.

Leave a Legacy: Your donation creates a lasting impact, preserving Jain values and heritage for generations to come, with your name recognized as a key supporter.

Be a Pillar of Unity: Lead the way in fostering unity among Jains, demonstrating how your vision and generosity strengthen our collective identity.

Drive Community Progress: Your contribution propels the entire Jain community in the U.S. forward, supporting initiatives that benefit spiritual, cultural, and social growth.

Stand Out as a Changemaker: Elevate your stature as a leader who makes a difference, enabling transformative experiences and programs at the Convention.

Thank You



JAINA CONVENTION 2025

Unity in Diversity: A Path to Peace

July 3 - 6, 2025 | Chicago, IL

Payment Instruction

- Donate using Zelle - Convention@jaina.org
- Donate by **Credit / Debit Card**
- Mail your Donations in favor of JAINA Convention : **JAINA Treasurer, 148 Tradewinds Cir. South Daytona, FL, 32119**

JAINA accepts gifts of stocks.

JAINA can accept donations from your Rupee account in India.

- Your donation is tax-deductible.
- JAINA (Federation of Jain Associations in North America) is a Non-Profit, tax-exempt organization registered under IRS Section 501 (C) (3) EL# 54-1280028

**LARGEST IMPORTER &
DISTRIBUTOR
IN NORTH AMERICA**

MSI RESIDENTIAL
COMMERCIAL
HOSPITALITY

Making Dream Surfaces Attainable



CAPABILITIES ON SUPPLYING

- ☛ LVT
- ☛ TILES
- ☛ QUARTZ
- ☛ NATURAL STONE
- ☛ VANITY TOPS TO SIZE
- ☛ VANITY BASE TO SIZE
- ☛ TABLE TOPS
- ☛ THRESHOLDS
- ☛ WINDOW SILLS
- ☛ SHOWER SURROUNDS
- ☛ SHOWER PANS
- ☛ SHOWER DOORS
- ☛ SINKS
- ☛ FAUCETS
- ☛ ROBE HOOKS
- ☛ TOWEL BARS
- ☛ TOILET PAPER HOLDERS
- ☛ LED MIRRORS
- ☛ TURF
- ☛ POOL/EXTERIOR PAVERS STONE
- ☛ LEDGERS



☎ 847-725-6534 | Email: MSI_chicago@msisurfaces.com

www.msisurfaces.com